

Small Signal Zener Diodes

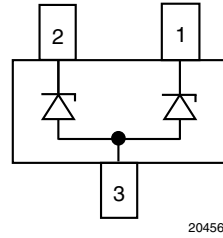

20456

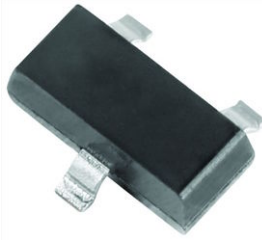

LINKS TO ADDITIONAL RESOURCES



MARKING (example only)

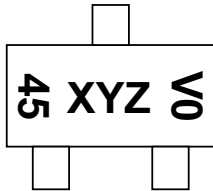

XYZ = type code
 45 = working week
 0 = year
 V = Vishay

FEATURES

- Silicon planar Zener diodes
- The Zener voltages are graded according to the international E24 standard. Standard Zener voltage tolerance is $\pm 5\%$, indicated by the "C" in the ordering code. Replace "C" with "B" for $\pm 2\%$ tolerance.
- AEC-Q101 qualified available
- ESD capability acc. to AEC-Q101: human body model: > 8 kV, machine model: > 800 V
- Base P/N-E3 - RoHS-compliant, commercial grade
- Base P/N-HE3_A - RoHS-compliant, AEC-Q101 qualified
- Material categorization: for definitions of compliance please see www.vishay.com/doc?99912

PRIMARY CHARACTERISTICS

PARAMETER	VALUE	UNIT
V_Z range nom.	2.2 to 75	V
Test current I_{ZT}	2; 5	mA
V_Z specification	Pulse current	
Circuit configuration	Common anode	

ORDERING INFORMATION

DEVICE NAME	ORDERING CODE	ZENER VOLTAGE TOLERANCE	AEC-Q101 QUALIFIED	TAPED UNITS PER REEL	MINIMUM ORDER QUANTITY
AZ23 series	AZ23C2V4-E3-08 to AZ23C75-E3-08	5 %	no	3000 (8 mm tape on 7" reel)	15 000
	AZ23B2V4-E3-08 to AZ23B75-E3-08	2 %	no		
	AZ23C2V4-HE3_A-08 to AZ23C75-HE3_A-08	5 %	yes		
	AZ23B2V4-HE3_A-08 to AZ23B75-HE3_A-08	2 %	yes		
	AZ23C2V4-E3-18 to AZ23C75-E3-18	5 %	no	10 000 (8 mm tape on 13" reel)	10 000
	AZ23B2V4-E3-18 to AZ23B75-E3-18	2 %	no		
	AZ23C2V4-HE3_A-18 to AZ23C75-HE3_A-18	5 %	yes		
	AZ23B2V4-HE3_A-18 to AZ23B75-HE3_A-18	2 %	yes		

PACKAGE

PACKAGE NAME	WEIGHT	MOLDING COMPOUND FLAMMABILITY RATING	MOISTURE SENSITIVITY LEVEL	SOLDERING CONDITIONS
SOT-23	9.2 mg	UL 94 V-0	MSL level 1 (according J-STD-020)	Peak temperature max. 260 °C

ABSOLUTE MAXIMUM RATINGS

PARAMETER	TEST CONDITION	SYMBOL	VALUE	UNIT
Power dissipation	$R_{thJL} = 250$ K/W	P_{tot}	500	mW
	On FR-4 board with recommended soldering footprint	P_{tot}	300	mW
Thermal resistance junction to lead		R_{thJL}	250	K/W
Thermal resistance junction to ambient	According to JEDEC® 51-3 on FR-4 board with recommended soldering footprint	R_{thJA}	420	K/W
Junction temperature		T_j	150	°C
Storage temperature range		T_{stg}	-65 to +150	°C
Operating temperature range		T_{op}	-55 to +150	°C



ELECTRICAL CHARACTERISTICS ($T_{amb} = 25\text{ }^{\circ}\text{C}$, unless otherwise specified)												
PART NUMBER	MARKING CODE	ZENER VOLTAGE RANGE			TEST CURRENT		REVERSE LEAKAGE CURRENT		DYNAMIC RESISTANCE $f = 1\text{ kHz}$		TEMPERATURE COEFFICIENT	
		V_Z at I_{ZT1}			I_{ZT1}	I_{ZT2}	I_R at V_R		Z_Z at I_{ZT1}	Z_{ZK} at I_{ZT2}	α_{VZ} at I_{ZT1}	
		V			mA		μA	V	Ω		$10^{-4}/^{\circ}\text{C}$	
		MIN.	NOM.	MAX.			MAX.		MAX.	MAX.	MIN.	MAX.
AZ23C2V2	D77	2.09	2.2	2.31	5	1	100	1	120	600	-9	-4
AZ23C2V4	D78	2.28	2.4	2.52	5	1	50	1	100	600	-9	-4
AZ23C2V7	D41	2.57	2.7	2.84	5	1	20	1	83	500	-9	-4
AZ23C3V0	D42	2.85	3.0	3.15	5	1	10	1	95	500	-9	-3
AZ23C3V3	D43	3.14	3.3	3.47	5	1	5	1	95	500	-8	-3
AZ23C3V6	D44	3.42	3.6	3.78	5	1	5	1	90	500	-8	-3
AZ23C3V9	D45	3.71	3.9	4.10	5	1	3	1	90	500	-7	-3
AZ23C4V3	D46	4.09	4.3	4.52	5	1	3	1	90	500	-6	-1
AZ23C4V7	D47	4.47	4.7	4.94	5	1	3	2	78	500	-5	2
AZ23C5V1	D48	4.85	5.1	5.36	5	1	2	2	60	480	-3	4
AZ23C5V1	D48	4.85	5.1	5.36	5	1	0.1	0.8			-3	4
AZ23C5V6	D49	5.32	5.6	5.88	5	1	1	2	40	400	-2	6
AZ23C5V6	D49	5.32	5.6	5.88	5	1	0.1	1			-2	6
AZ23C6V2	D50	5.89	6.2	6.51	5	1	3	4	10	150	-1	7
AZ23C6V2	D50	5.89	6.2	6.51	5	1	0.1	2			-1	7
AZ23C6V8	D51	6.46	6.8	7.14	5	1	2	4	8	80	2	7
AZ23C6V8	D51	6.46	6.8	7.14	5	1	0.1	3			2	7
AZ23C7V5	D52	7.13	7.5	7.88	5	1	0.1	5	7	50	3	7
AZ23C8V2	D53	7.79	8.2	8.61	5	1	0.1	6	7	50	4	7
AZ23C9V1	D54	8.65	9.1	9.56	5	1	0.1	7	10	50	5	8
AZ23C10	D55	9.50	10	10.50	5	1	0.1	7.5	15	70	5	8
AZ23C11	D56	10.45	11	11.55	5	1	0.1	8.5	20	70	5	9
AZ23C12	D57	11.40	12	12.60	5	1	0.1	9	20	90	6	9
AZ23C13	D58	12.40	13	13.65	5	1	0.1	10	25	110	7	9
AZ23C15	D59	14.25	15	15.60	5	1	0.05	11	30	110	7	9
AZ23C16	D60	15.30	16	16.80	5	1	0.05	12	40	170	8	9.5
AZ23C18	D61	17.10	18	18.90	5	1	0.05	14	45	170	8	9.5
AZ23C20	D62	19.00	20	21.00	5	1	0.05	15	50	220	8	10
AZ23C22	D63	20.90	22	23.10	5	1	0.05	17	55	220	8	10
AZ23C24	D64	22.80	24	25.20	5	1	0.05	18	70	220	8	10
AZ23C27	D65	25.65	27	28.35	2	0.5	0.05	20	80	250	8	10
AZ23C30	D66	28.50	30	31.50	2	0.5	0.05	22.5	80	250	8	10
AZ23C33	D67	31.35	33	34.65	2	0.5	0.05	25	80	250	8	10
AZ23C36	D68	34.20	36	37.80	2	0.5	0.05	27	87	250	8	10
AZ23C39	D69	37.05	39	40.95	2	0.5	0.05	29	87	300	10	12
AZ23C43	D70	40.85	43	45.15	2	0.5	0.05	32	97	375	10	12
AZ23C47	D71	44.65	47	49.35	2	0.5	0.05	35	97	375	10	12
AZ23C51	D72	48.45	51	53.55	2	0.5	0.05	38	100	400	10	12
AZ23C56	D73	53.20	56	58.80	2	0.5	0.05	42	135	425	9	11
AZ23C62	D74	58.90	62	65.10	2	0.5	0.05	46.5	150	450	9	12
AZ23C68	D75	64.60	68	71.40	2	0.5	0.05	51	200	475	10	12
AZ23C75	D76	71.25	75	78.75	2	0.5	0.05	56	250	500	10	12



ELECTRICAL CHARACTERISTICS ($T_{amb} = 25\text{ }^{\circ}\text{C}$, unless otherwise specified)												
PART NUMBER	MARKING CODE	ZENER VOLTAGE RANGE			TEST CURRENT		REVERSE LEAKAGE CURRENT		DYNAMIC RESISTANCE $f = 1\text{ kHz}$		TEMPERATURE COEFFICIENT	
		V_Z at I_{ZT1}			I_{ZT1}	I_{ZT2}	I_R at V_R		Z_Z at I_{ZT1}	Z_{ZK} at I_{ZT2}	α_{VZ} at I_{ZT1}	
		V			mA		μA	V	Ω		$10^{-4}/^{\circ}\text{C}$	
		MIN.	NOM.	MAX.			MAX.		MAX.	MAX.	MIN.	MAX.
AZ23B2V2	DG8	2.16	2.2	2.24	5	1	100	1	120	600	-9	-4
AZ23B2V4	DG9	2.35	2.4	2.45	5	1	50	1	100	600	-9	-4
AZ23B2V7	DD1	2.65	2.7	2.75	5	1	20	1	83	500	-9	-4
AZ23B3V0	DD2	2.94	3.0	3.06	5	1	10	1	95	500	-9	-3
AZ23B3V3	DD3	3.23	3.3	3.37	5	1	5	1	95	500	-8	-3
AZ23B3V6	DD4	3.53	3.6	3.67	5	1	5	1	90	500	-8	-3
AZ23B3V9	DD5	3.82	3.9	3.98	5	1	3	1	90	500	-7	-3
AZ23B4V3	DD6	4.21	4.3	4.39	5	1	3	1	90	500	-6	-1
AZ23B4V7	DD7	4.61	4.7	4.79	5	1	3	2	78	500	-5	2
AZ23B5V1	DD8	5.00	5.1	5.20	5	1	2	2	60	480	-3	4
							0.1	0.8				
AZ23B5V6	DD9	5.49	5.6	5.71	5	1	1	2	40	400	-2	6
							0.1	1				
AZ23B6V2	DE0	6.08	6.2	6.32	5	1	3	4	10	150	-1	7
							0.1	2				
AZ23B6V8	DE1	6.66	6.8	6.94	5	1	2	4	8	80	2	7
							0.1	3				
AZ23B7V5	DE2	7.35	7.5	7.65	5	1	0.1	5	7	50	3	7
AZ23B8V2	DE3	8.04	8.2	8.36	5	1	0.1	6	7	50	4	7
AZ23B9V1	DE4	8.92	9.1	9.28	5	1	0.1	7	10	50	5	8
AZ23B10	DE5	9.80	10	10.20	5	1	0.1	7.5	15	70	5	8
AZ23B11	DE6	10.78	11	11.22	5	1	0.1	8.5	20	70	5	9
AZ23B12	DE7	11.76	12	12.24	5	1	0.1	9	20	90	6	9
AZ23B13	DE8	12.74	13	13.26	5	1	0.1	10	25	110	7	9
AZ23B15	DE9	14.70	15	15.30	5	1	0.05	11	30	110	7	9
AZ23B16	DF0	15.68	16	16.32	5	1	0.05	12	40	170	8	9.5
AZ23B18	DF1	17.64	18	18.36	5	1	0.05	14	45	170	8	9.5
AZ23B20	DF2	19.60	20	20.40	5	1	0.05	15	50	220	8	10
AZ23B22	DF3	21.56	22	22.44	5	1	0.05	17	55	220	8	10
AZ23B24	DF4	23.52	24	24.48	5	1	0.05	18	70	220	8	10
AZ23B27	DF5	26.46	27	27.54	2	0.5	0.05	20	80	250	8	10
AZ23B30	DF6	29.40	30	30.60	2	0.5	0.05	22.5	80	250	8	10
AZ23B33	DF7	32.34	33	33.66	2	0.5	0.05	25	80	250	8	10
AZ23B36	DF8	35.28	36	36.72	2	0.5	0.05	27	87	250	8	10
AZ23B39	DF9	38.22	39	39.78	2	0.5	0.05	29	87	300	10	12
AZ23B43	DG0	42.14	43	43.86	2	0.5	0.05	32	97	375	10	12
AZ23B47	DG1	46.06	47	47.94	2	0.5	0.05	35	97	375	10	12
AZ23B51	DG2	49.98	51	52.02	2	0.5	0.05	38	100	400	10	12
AZ23B56	DG3	54.88	56	57.12	2	0.5	0.05	42	135	425	9	11
AZ23B62	DG5	60.76	62	63.24	2	0.5	0.05	46.5	150	450	9	12
AZ23B68	DG6	66.64	68	69.36	2	0.5	0.05	51	200	475	10	12
AZ23B75	DG7	73.50	75	76.50	2	0.5	0.05	56	250	500	10	12

Note

(1) Tested with pulses $t_b = 5\text{ ms}$

TYPICAL CHARACTERISTICS ($T_{amb} = 25\text{ }^{\circ}\text{C}$, unless otherwise specified)

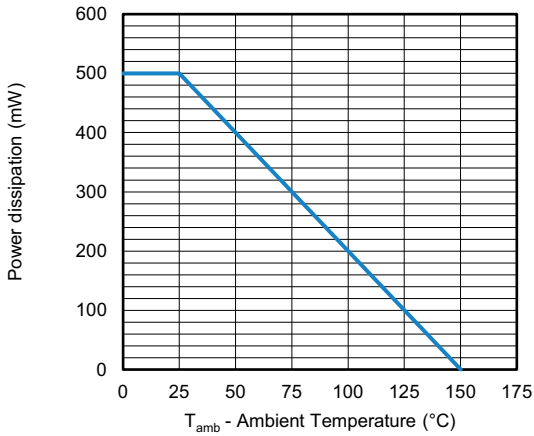

Fig. 1 - Admissible Power Dissipation vs. Ambient Temperature

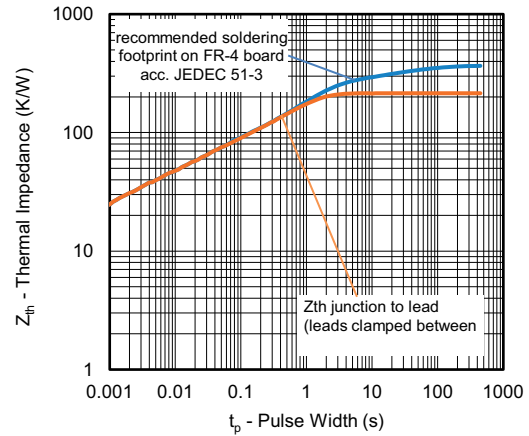
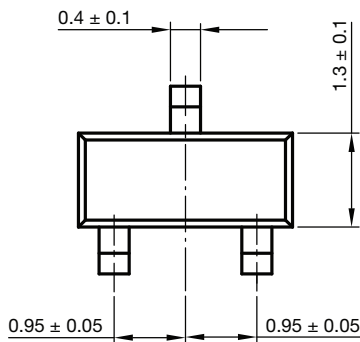
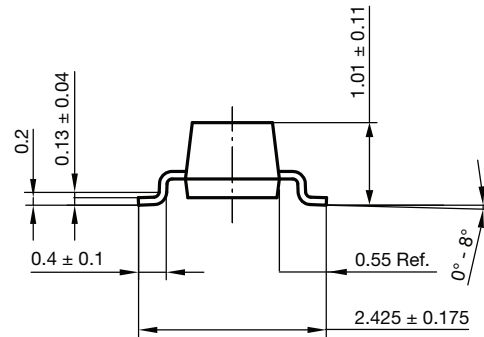
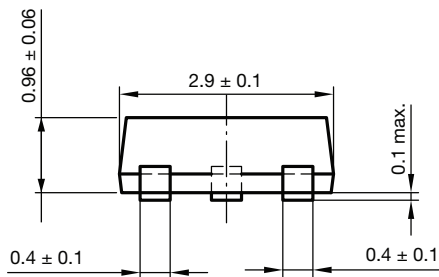
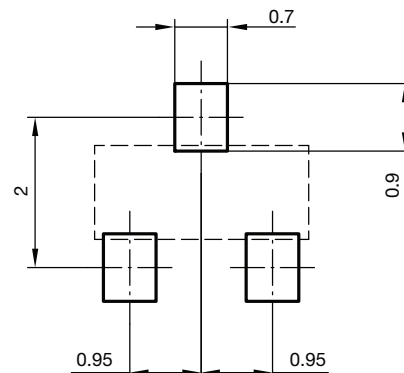

Fig. 2 - Thermal Impedance vs. Time

PACKAGE DIMENSIONS in millimeters (inches): **SOT-23**



Foot print recommendation:



Document no.: S8-V-3929.01-009 (4)
 Created - Date: 18. Oct. 2021
 Rev. 01 - Date: 18. Jan. 2022



ORIENTATION IN CARRIER TAPE

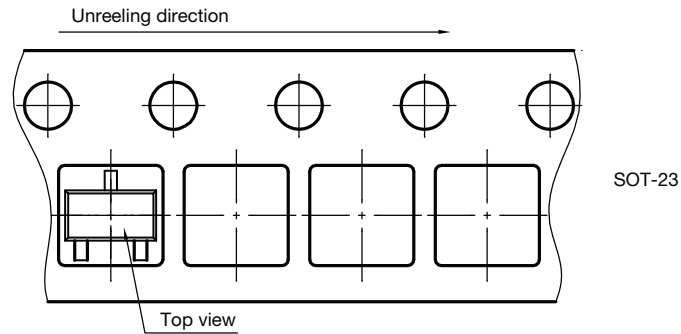

S8-V-3929.01-006 (4)
Created Date: 04.02.2010
Rev. 02 Date: 07.11.2022

CARRIER TAPE



B-B Section

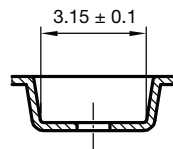

Document no.: S8-V-3929.01-005 (4)
Created - Date: 04. Feb. 2010



Disclaimer

ALL PRODUCT, PRODUCT SPECIFICATIONS AND DATA ARE SUBJECT TO CHANGE WITHOUT NOTICE TO IMPROVE RELIABILITY, FUNCTION OR DESIGN OR OTHERWISE.

Vishay Intertechnology, Inc., its affiliates, agents, and employees, and all persons acting on its or their behalf (collectively, "Vishay"), disclaim any and all liability for any errors, inaccuracies or incompleteness contained in any datasheet or in any other disclosure relating to any product.

Vishay makes no warranty, representation or guarantee regarding the suitability of the products for any particular purpose or the continuing production of any product. To the maximum extent permitted by applicable law, Vishay disclaims (i) any and all liability arising out of the application or use of any product, (ii) any and all liability, including without limitation special, consequential or incidental damages, and (iii) any and all implied warranties, including warranties of fitness for particular purpose, non-infringement and merchantability.

Statements regarding the suitability of products for certain types of applications are based on Vishay's knowledge of typical requirements that are often placed on Vishay products in generic applications. Such statements are not binding statements about the suitability of products for a particular application. It is the customer's responsibility to validate that a particular product with the properties described in the product specification is suitable for use in a particular application. Parameters provided in datasheets and / or specifications may vary in different applications and performance may vary over time. All operating parameters, including typical parameters, must be validated for each customer application by the customer's technical experts. Product specifications do not expand or otherwise modify Vishay's terms and conditions of purchase, including but not limited to the warranty expressed therein.

Hyperlinks included in this datasheet may direct users to third-party websites. These links are provided as a convenience and for informational purposes only. Inclusion of these hyperlinks does not constitute an endorsement or an approval by Vishay of any of the products, services or opinions of the corporation, organization or individual associated with the third-party website. Vishay disclaims any and all liability and bears no responsibility for the accuracy, legality or content of the third-party website or for that of subsequent links.

Vishay products are not designed for use in life-saving or life-sustaining applications or any application in which the failure of the Vishay product could result in personal injury or death unless specifically qualified in writing by Vishay. Customers using or selling Vishay products not expressly indicated for use in such applications do so at their own risk. Please contact authorized Vishay personnel to obtain written terms and conditions regarding products designed for such applications.

No license, express or implied, by estoppel or otherwise, to any intellectual property rights is granted by this document or by any conduct of Vishay. Product names and markings noted herein may be trademarks of their respective owners.